

THE MOREPOWER PULLER®

LIST PRICES AND SPECIFICATIONS

Prices effective January 1, 2019

Note: prices change every year on January 1st
 Specifications and weights of the More Power Puller are subject to change without notice
 All prices F.O.B. Newark, Ohio

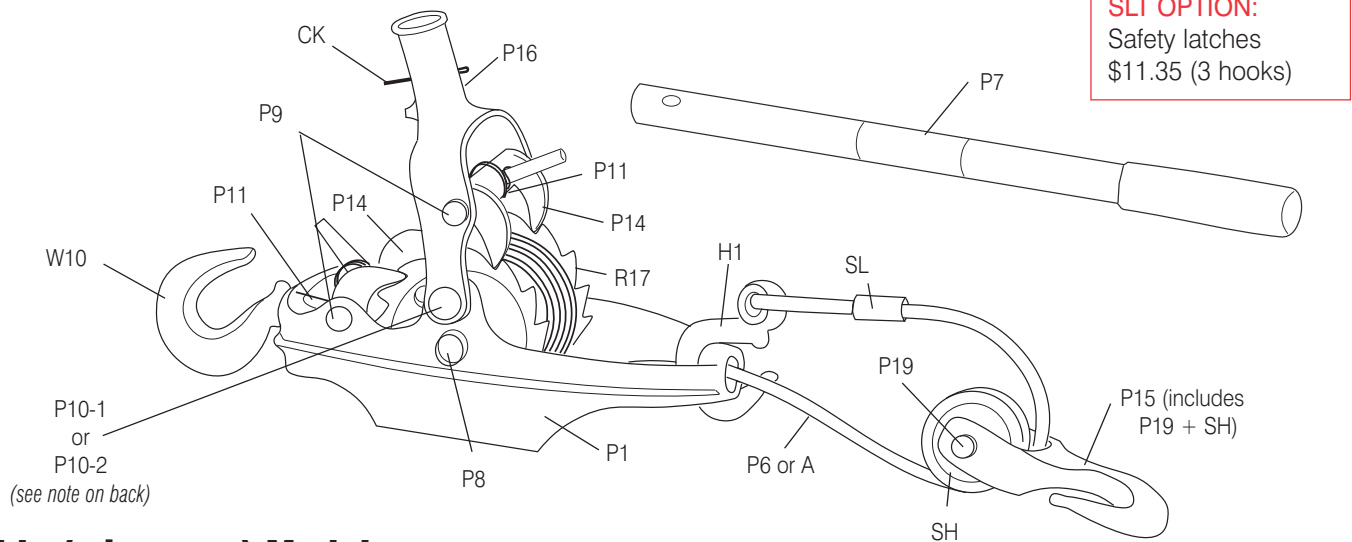

Cable (wire rope) Models

MODEL NUMBER	CABLE/ROPE LENGTH (single line)	CAPACITY Dead Lift Rating (double line)	CAPACITY Pull/Drag Rating* (double line)	CABLE/ROPE SIZE	WEIGHT/LBS Puller	Shipping	PRICE
2-20	20 feet	2 ton (4,000 lbs.)	4 ton (8,000 lbs.)*	5/16"	25.2	27	\$ 286.10
2-20-SLT	20 feet	2 ton (4,000 lbs.)	4 ton (8,000 lbs.)*	5/16"	25.4	27	297.45
2-30	30 feet	2 ton (4,000 lbs.)	4 ton (8,000 lbs.)*	5/16"	26.8	29	294.85
2-30-SLT	30 feet	2 ton (4,000 lbs.)	4 ton (8,000 lbs.)*	5/16"	27.0	29	306.20
2-35	35 feet	2 ton (4,000 lbs.)	4 ton (8,000 lbs.)*	5/16"	27.6	29	302.70
2-35-SLT	35 feet	2 ton (4,000 lbs.)	4 ton (8,000 lbs.)*	5/16"	27.8	29	314.05
3-20	20 feet	3 ton (6,000 lbs.)	6 ton (12,000 lbs.)*	5/16"	26.0	28	298.25
3-20-SLT	20 feet	3 ton (6,000 lbs.)	6 ton (12,000 lbs.)*	5/16"	26.2	28	309.60

AmSteel®Blue Synthetic Rope Models

2-20-A-SLT	20 feet	2 ton (4,000 lbs.)	4 ton (8,000 lbs.)*	5/16" AmSteel-Blue	22.8	25	\$ 340.55
3-35-A-SLT	35 feet	3 ton (6,000 lbs.)	6 ton (12,000 lbs.)*	5/16" AmSteel-Blue	24.2	26	399.70

*Pull/Drag Ratings for comparison only. Winches and a few pullers are rated this way. There are too many variables to determine a scientific drag/pull rating, however, the commonly used ratio is 2:1. Variables include surface type (mud/rocks +), the incline, type of object being dragged, etc. The Pull/Drag Rating is mainly used for an object with wheels (vehicle).

SEE PARTS PRICING ON BACK



85 Dayton Road • P. O. Box 888 • Newark, Ohio 43058-0888 • USA
 Hours: 8:30 – 5:00 ET • Email: sales@wyeth-scott.com
 Web page: www.wyeth-scott.com
 Phone: 800/743-4521 or 740/345-4528 • Fax: 740/345-0123

THE MORE POWER PULLER® Prices effective January 1, 2019 • Note: Prices change every year on Jan. 1st

Parts - 2 Ton Model

A-20-H1-SLT	20' of 5/16" AmSteel-Blue Synthetic rope w/H1 end hook (w/safety latch) installed on rope (RF included but not 100% installed)	\$ 95.74
A-35-H1-SLT	35' of 5/16" AmSteel-Blue Synthetic rope w/H1 end hook (w/safety latch) installed on rope (RF included but not 100% installed)	154.24
CK	Cotter Key	.15
H1	Hook (end of cable/rope)	9.77
H1-SLT	Hook with safety latch (end of cable/rope)	13.26
P1	Frame	70.45
P620	20' of 5/16" cable with rivet attachment (ready to apply to reel)	42.95
P620-H1	20' of 5/16" cable w/H1 end hook attached to cable (RF included, but not 100% installed)	53.97
P620-H1-SLT	20' of 5/16" cable w/H1 end hook (w/safety latch) attached to cable (RF included, but not 100% installed)	57.46
P630	30' of 5/16" cable with rivet attachment (ready to apply to reel)	51.75
P630-H1	30' of 5/16" cable w/H1 end hook attached to cable (RF included, but not 100% installed)	62.77
P630-H1-SLT	30' of 5/16" cable w/H1 end hook (w/safety latch) attached to cable (RF included, but not 100% installed)	66.26
P635	35' of 5/16" cable with rivet attachment (ready to apply to reel)	56.10
P635-H1	35' of 5/16" cable w/H1 end hook attached to cable (RF included, but not 100% installed)	67.12
P635-H1-SLT	35' of 5/16" cable w/H1 end hook (w/safety latch) attached to cable (RF included, but not 100% installed)	70.61
P7	Tubular safety handle	4.70
P7-EXT	Safety handle extension (18" long w/red grip) (inserts into P7) – 2 ton unit	7.55
P8	Tubular rivet for reel	2.15
P9	Rivet for pawl	1.80
P10-1	Shoulder rivet (attach yoke, 2 required)	1.15
P10-2	Shoulder rivet (attach yoke, 2 required)	1.15
P11	Spring for pawl on yoke or frame	1.10
P13	Cable Clamp for 5/16 cable (2 required)	1.34
P14	Pawl	12.60
P15	Tackle block hook (includes P19 & SH)	52.00
P15-SLT	Tackle block hook with safety latch (includes P19 and SH)	55.93
P16	Yoke with 2 shoulder rivets	37.25
P19	Clevis pin (w/hitch pin) (attach SH to P15)	2.39
P22	Drag wave washer for reel	.86
R17	Reel	89.30
RF	Rivet and ferrule - cable to reel attachment	5.75
SH	Sheave	8.58
SL	Aluminum alloy sleeve (mfg. installed)	1.25
SLT-1	Safety latch (for H1 hook)	3.49
SLT-2	Safety latch (for P15, P15-3 & W10 hooks)	3.93
W10	Frame hook (includes nut)	15.75
W10-SLT	Frame hook with safety latch (includes nut)	19.68

P10-1 rivet fits older models from 1934 to some from 2013 and is flush to the yoke. P10-2 is a newer rivet on models beginning in 2012/13 and extends 1/8" beyond the yoke. Check your model before you order!

**REPAIR INSTRUCTIONS
AVAILABLE ONLINE AT
www.wyeth-scott.com
or by fax.**

Parts - 3 Ton Model

Parts same as 2 ton except as noted below.

P620	20' of 5/16" cable with rivet attachment (ready to apply to reel)	42.95
P620-H1	20' of 5/16" cable w/H1 end hook attached to cable (RF included, but not 100% installed)	53.97
P620-H1-SLT	20' of 5/16" cable w/H1 end hook (w/safety latch) attached to cable (RF included, but not 100% installed)	57.46
P7-3	Tubular safety handle - 3 ton unit	5.75
P7-3-EXT	Safety handle extension (18" long w/blue grip) (inserts into P7-3) – 3 ton unit	8.65
P15-3	Tackle block hook (includes P19-3 & SH-3)	65.00
P15-3-SLT	Tackle block hook with safety latch (includes P19-3 and SH-3)	68.93
P19-3	Clevis pin (w/hitch pin) (attach SH-3 to P15-3)	3.45
SH-3	Sheave	9.77

Slings (extension cables w/loop on each end). Custom slings available by request.

C05	5' sling made with 5/16" cable	8.25 net
C10	10' sling made with 5/16" cable	13.20 net
C25	25' sling made with 5/16" cable	28.10 net
C50	50' sling made with 5/16" cable	53.60 net
C100	100' sling made with 5/16" cable	103.90 net